

STAMPATO SU CARTA RICICLATA. NESSUN ALBERO E' STATO ABBATTUTO PER PRODURRE QUESTO MANUALE

Cod. 0340.951 - Ed.01 11/00

**ROYAL**

CAPPUCCINO

TYPE SUP 016

- User's and maintenance booklet

 **Saeco** 

HOUSEHOLD USE ONLY

*We congratulate for having bought this top-quality espresso machine and thank you for choosing Saeco.  
Before operating the machine, we recommend to read the following instructions thoroughly which explain how to use, clean and maintain the machine.*

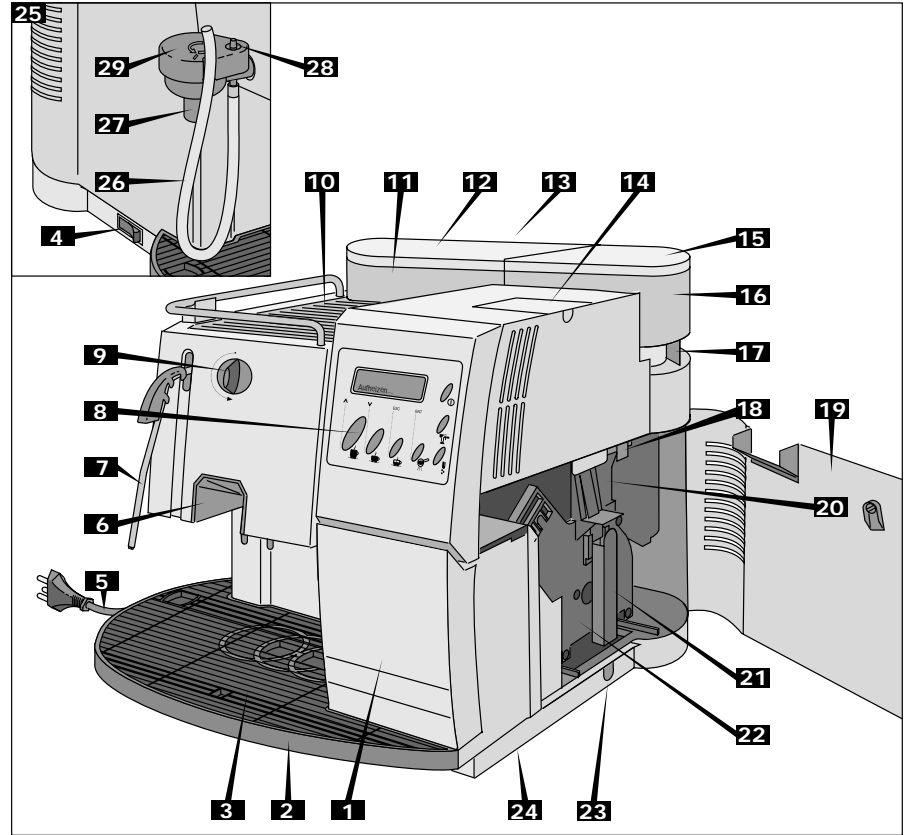

# 4

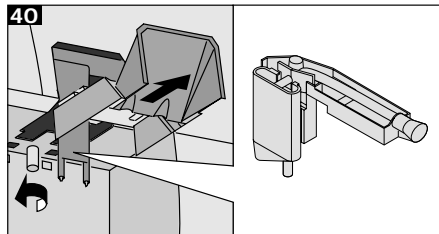
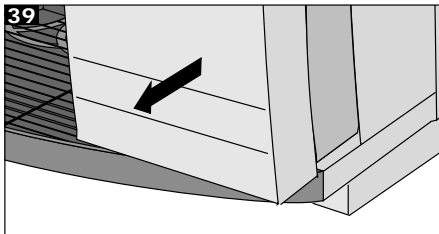
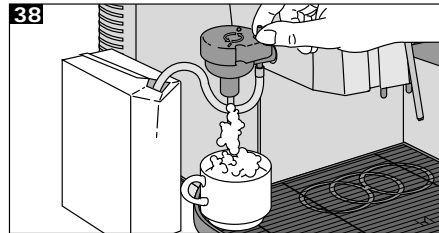
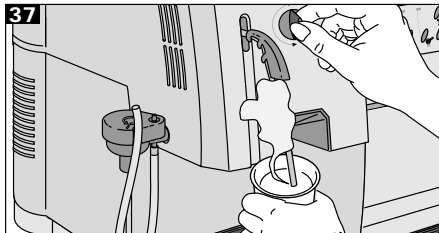
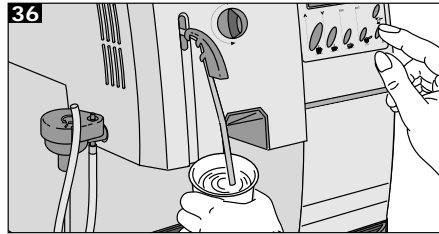
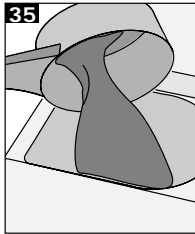
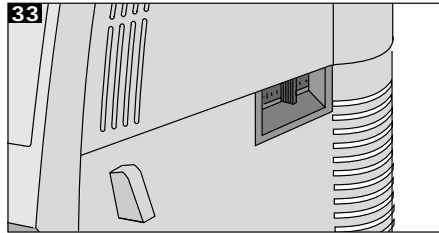
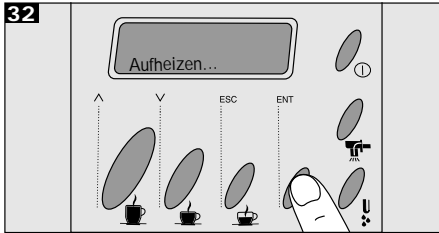
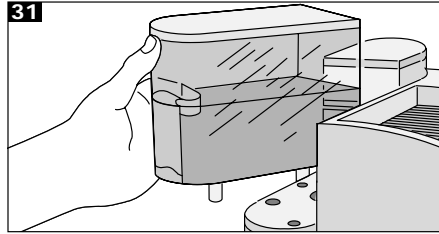
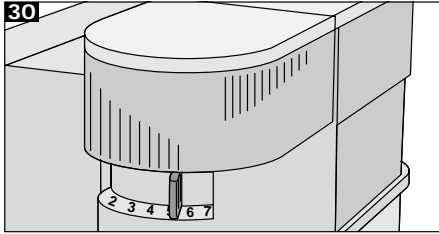

# 5

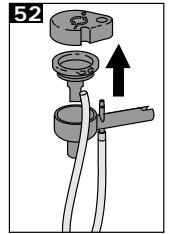
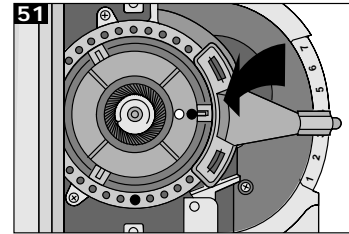
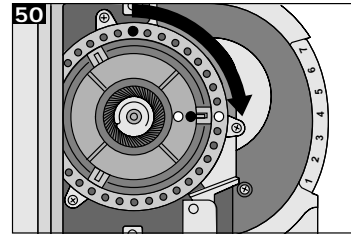
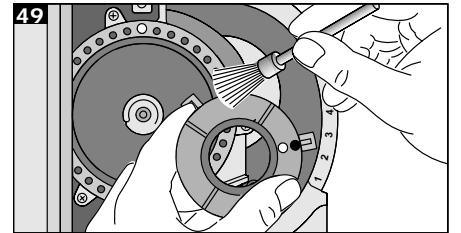
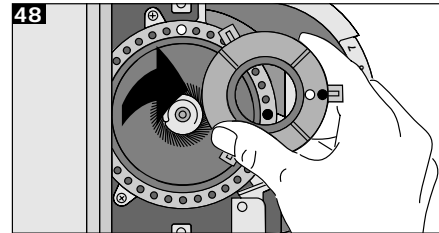
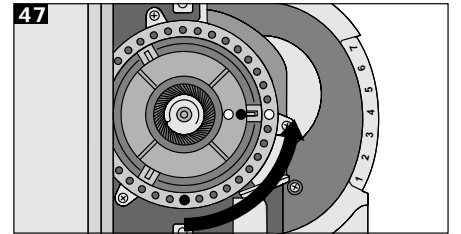
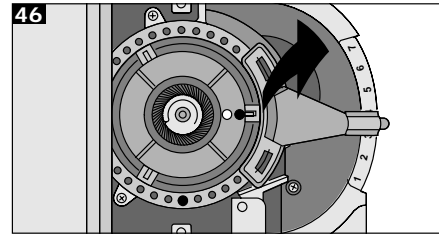
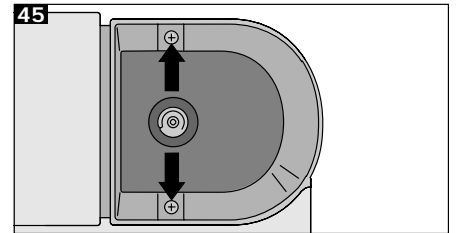
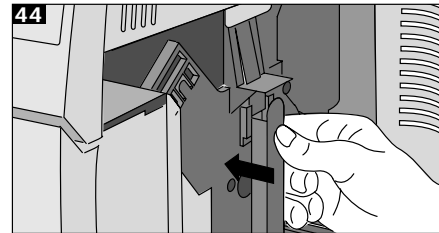
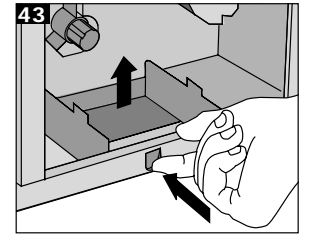
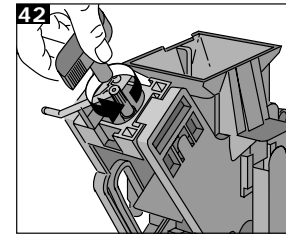
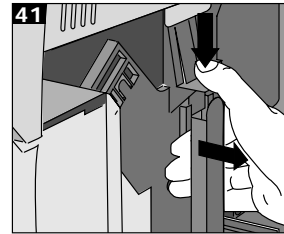

### How to use the instructions

These instructions cannot anticipate every possible use of the machine.

For further information or questions concerning specific situations or problems, please contact the local dealer or manufacturer directly.



The warning triangle shows all important safety indications to ensure the user's safety.

The non-observance of said instructions may cause serious injuries!

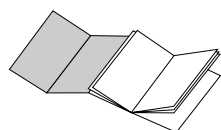

The first cover page of the manual shows figures relevant to the text. Thus, keep it open while reading the instructions.

## SAVE THESE INSTRUCTIONS



The lightning flash with arrowhead symbol, within an equilateral triangle, is intended to alert the user to the presence of uninsulated «dangerous voltage» within the product's enclosure that may be of sufficient magnitude to constitute a risk of fire or electric shock to persons.



The exclamation point within an equilateral triangle is intended to alert the user to the presence of important operating and maintenance (servicing) instructions in the literature accompanying the appliance.

### Table of contents

Page		Page	
75	Technical data	82	Programming the machine
77	Safety rules	86	Recommendation
79	Machine controls and parts	87	Grind adjustment
79	Description of the control panel	88	Brewing
80	Unpacking/Installation	90	Incorporated Safety Devices
80	Power supply connection	91	Cleaning and maintenance operations
80	Starting and use	94	Disposal
81	Drainage	95	Troubleshooting

Voltage rating	see rating plate on the back of the machine
Nominal power	see rating plate on the back of the machine
Dimensions (length x width x height)	approx. 385 x 330 x 395 mm
Machine case	metal and plastic material
Weight	approx. 1.6 kg
Cable length	approx. 1.2 m
System	free flow thermal cut-out, alternating piston pump
Temperature control	electronic
Coffee grinder adjustment	grinding adjustment device
Coffee grounds ejection	automatic
Ground coffee dosage	coffee releasing device
Cup programming	0-250 ml approx.
Water tank	removable, transparent tank
Water regulation	electronic, continuous
Capacity	- water tank approx. 2.4 litres - bean coffee container 300g bean coffee
Steam/hot water dispensing tube	adjustable, supplied with burn protection
Steam/hot water dispensing	adjustable, continuous
Heating time	approx. 2 min.
Brewing time	- espresso coffee approx. 20s/cup - coffee approx. 30s/cup - hot water approx. 60s/cup - milk (cappuccino) approx. 60-90s cream/cup
Overheating protection	incorporated
Insulation	protection range I
Approvals	see rating plate on the back of the machine
In compliance with EN regulation	EN 60335-2-15(96) · EN 60335-2-14(96) · EN 55014
Warranty	in compliance with the warranty certificate enclosed herein

### Accessories (included in the machine price)

Measuring spoon
Central unit key
Cleaning brush
Water hardness detecting strips

The manufacturer reserves the right to make improvements to the appliance due to technological advancement.

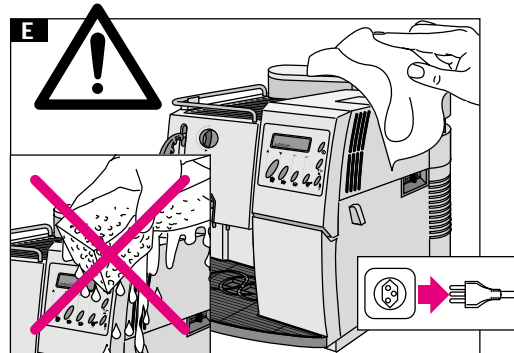
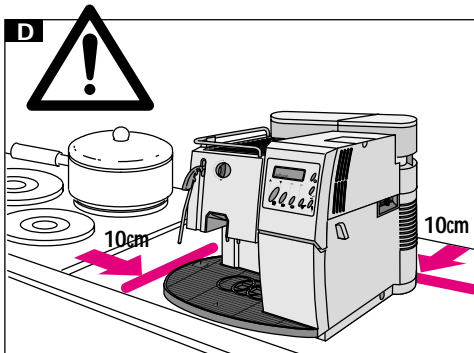
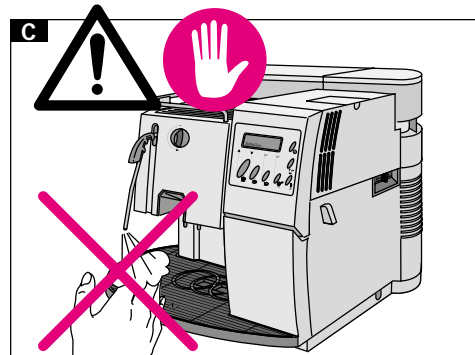
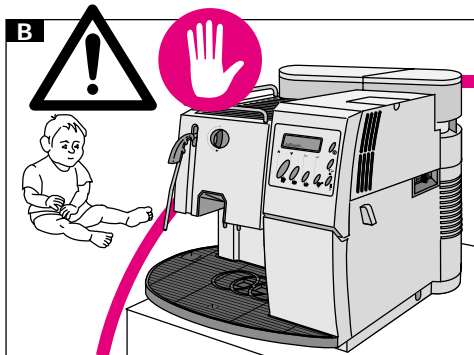
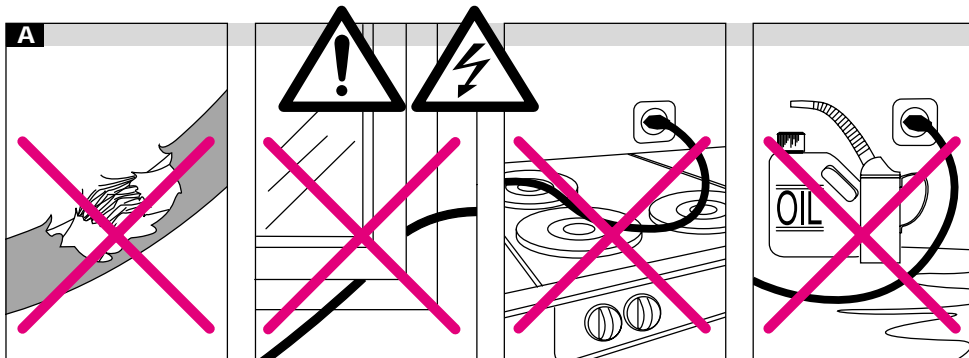

**Electrical parts should never be in contact with water: danger of short-circuit! Steam and hot water may cause burns. Never direct steam or water jets towards the body; special attention must be paid when touching the steam/hot water spout and the heating plate: danger of burns!**

**This machine must be used exclusively for the purposes it has been manufactured.**

Do not make technical changes for any reason whatsoever; any improper use is forbidden, due to the risks which might occur!

#### Warnings

The machine shall only be used by adults and properly instructed persons.

#### Voltage

Never touch parts under current! They might cause electric shocks, serious injuries and death. The machine must be connected to a socket with suitable voltage. Voltage must correspond to the voltage shown on the appliance rating plate.

#### A Power cord

Never use the machine with a defective power cord. Replace defective power cords and plugs, contacting authorised personnel. Do not extend the power cord around corners, sharp edges or over hot parts and protect it from oil. Do not shift or move the machine by pulling its power cord. Do not unplug the machine by pulling the power cord and never touch it with wet hands. Make sure the power cord does not hang from tables or shelves.

#### B Keep children away

Do not allow children to play with the machine. Children are not aware of the potential danger caused by electric appliances.

#### Positioning

Place the machine on a plane surface, where nobody can turn it upside down or be hurt. Hot water or overheated steam might escape from the machine: danger of burns! Never use the coffee machine outdoors or inside rooms with low temperature conditions. Do not place the machine on hot surfaces or in the proximity of open flames to avoid possible damages of the case.

#### C Danger of burns

Do not direct the overheated steam or hot water jet towards you or other people. Do not touch hot surfaces, such as the steam/hot water spout.

#### D Necessary space

For a proper operation of the machine it is advisable to keep to the following indications:

- choose a levelled surface
- choose a properly lit and hygienic room provided with accessible sockets
- leave a minimum distance of 100 mm between the machine and the wall

#### E Cleaning

Before cleaning the machine, make sure to switch off all keys and unplug the machine. Wait until the machine cools down. Never plunge the machine into water! Do not tamper with the inner parts of the machine and never open the machine.

#### Repair/maintenance

In case of defect or suspected damage following a fall, unplug the machine immediately. Never use a defective appliance. Only skilled personnel are authorised to carry out repairs. The manufacturer declines any liability whatsoever, should repairs fail to be carried out by authorised personnel.

In case of fires, use carbon dioxide (CO<sub>2</sub>) extinguishers. Never use water or powder extinguishers.

## IMPORTANT SAFEGUARDS

- a) A short power-supply cord (or detachable power-supply cord) is to be provided to reduce risks resulting from becoming entangled in or tripping over a longer cord.
- b) Longer detachable power-supply cords or extension cords are available and may be used if care is exercised in their use.
- c) If a long detachable power-supply cord or extension cords is used,
- 1) The marked electrical rating of the detachable power-supply cord or extension cord should be at least as great as the electrical rating of the appliance,
  - 2) If the appliance is of the grounded type, the extension cord should be a grounding-type 3-wire cord, and
  - 3) The longer cord should be arranged so that it will not drape over the counter top or table top where it can be pulled on by children or tripped over.

- |  |  |
|--|--|
| 1 Coffee grounds container                   | 16 Coffee bean container                                   |
| 2 Drip tray                                  | 17 Grind adjustment lever                                  |
| 3 Cup holder surface                         | 18 Coffee dosage adjustment lever                          |
| 4 Main switch                                | 19 Service door  |
| 5 Power cord                                 | 20 Filling funnel  |
| 6 Coffee dispensing unit                     | 21 Handle for assembling and disassembling of central unit |
| 7 Steam/hot water spout with burn-protection | 22 Central unit  |
| 8 Control panel                              | 23 Coffee rest drawer                                      |
| 9 Steam knob                                 | 24 Swivel  |
| 10 Cup heating plate                         | 25 Cappuccinatore  |
| 11 Water tank                                | 26 Suction pipe  |
| 12 Water tank cover                          | 27 Dispenser   |
| 13 Water level                               | 28 Cappuccinatore adjusting valve                          |
| 14 Pre-ground coffee container with cover    | 29 Cappuccinatore cover                                    |
| 15 Coffee bean container cover               |  |

### Description of the control panel

Digital display

Standby switch:  
energy saving function on/off

Selection key for 1 or 2 cups of tall coffee or key  
" ^ " in the programming mode

Selection key for 1 or 2 cups of regular coffee  
or key " v " in the programming mode

Selection key for 1 or 2 cups of espresso coffee  
or "ESC" in the programming mode

Pre-ground coffee selection button or "ENT" in  
the programming mode

Cappuccino selection key

Hot water on/off key

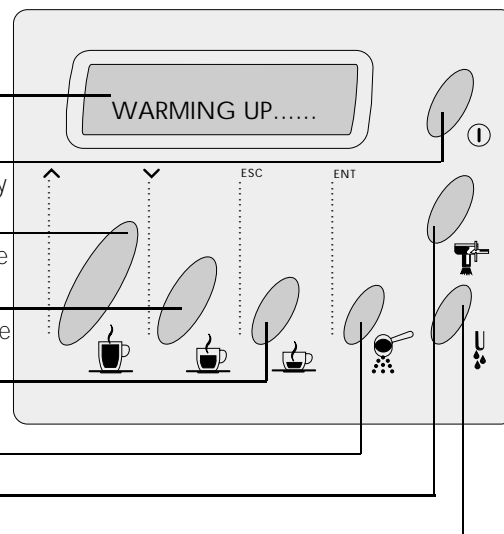

## Unpacking/installation

Standard packing is strong enough to protect the machine during mail shipping. Keep this package to return the machine to the manufacturer, whenever necessary.

Before installing the machine, keep to the safety indications at page 77.

Whenever possible, use the machine with swivel (24). When installing the machine, make sure the swivel is always fitted in the provided area on the lower side of the machine.

### Power supply connection

**Warning:** electric current may cause death!  
Always keep to safety rules.

The coffee machine must be connected to an adequate socket. Voltage must suit to the voltage specified on the appliance rating plate.

Never use defective power cords! Defective power cords and plugs must be replaced by an authorised personnel.

Should an extension cord be used, check its perfect conditions. The extension cord must have a minimum section of 1,5 mm<sup>2</sup> or 16 AWG and must be supplied with a three-pole plug/socket.

### Starting and use

**Parts under current shall never be in contact with water: danger of short-**

**circuit! Overheated steam and hot water may cause burns. Do not direct steam or water jet towards the body; furthermore, great attention must be given when touching either the steam/hot water spout or the heating plate: danger of burns!**

Never use the machine without water or coffee beans.

Remove measuring spoon, brush and the central unit key from the coffee grounds container (1) and keep them within reach.

Unwind the power cord (5) from the rear side of the machine.

Remove the cover (15) and fill the container with coffee beans (300 g approx.), then, replace the cover. Adjust grinding by means of the grind adjustment lever (17), positioning it on point "5" of the scale.

Never fill the coffee bean container with other products since they might damage the machine!

Before filling the container with coffee beans, make sure the pre-ground coffee container (14) is closed to prevent coffee beans from falling into it. They might damage the machine!

Remove water tank (11) from the machine, remove its cover (12) and fill it with cold water (approx. 2.4l). A valve on the tank bottom prevents water from escaping.

**Before installing the water tank in the machine, make sure the coffee bean container cover is properly fitted.**

**31**  
Install the water tank, slightly pressing over it to fit the valve which will open automatically.



Do not fill the tank with an excessive quantity of water.



Always fill the tank with fresh water only: hot water as well as other fluids might damage the tank. Never use carbon dioxide added water.



Do not switch on the machine on if the water tank is empty: always make sure there is enough water in the tank!

Connect the plug to the socket and press the main switch. The following message will be displayed:

"WARMING UP....."

Should

"ENERGY " "  
"SAVING "

be displayed, press button (1) "Standby" to deactivate the energy saving mode.

**Drainage**

Direct the steam/hot water spout on the drip tray (2). Place a cup or another suitable container under the dispensing tube, then turn the steam/hot water knob counterclockwise. The pump starts automatically. Wait until a regular water jet is obtained, then close the knob. The machine is now drained and ready to work.

The following message will be displayed:

"SELECT PRODUCT " "  
"READY FOR USE "

**Important: It is advisable to drain the machine before the first start, after a prolonged period the machine has not been used or whenever the water tank has been completely emptied.**

Furthermore, should the pump be defective, the display shows:

"VENTILATE "

**Programming the machine**

**32**  
To enter the programming mode, press the key ENT (☉ pre-ground coffee) when the machine is on and keep it pressed until the first two lines of the programming mode are displayed:

"1 LANGUAGE " "  
"2 SYSTEM 2 "

At the end of the line a blinking asterisk is displayed, which can be moved up and down with the keys ^v (tall and regular coffee).

If the asterisk is on the first menu, press v button to move it on the second menu and vice versa. The display shows the following sequence of messages:

- |                   |                   |
|-------------------|-------------------|
| 1 LANGUAGE        | 10 PROG. H. WATER |
| 2 SYSTEM 2        | 11 PROG. CAPPUC.  |
| 3 WATER HARDN.    | 12 TOTAL COFFEE   |
| 4 CUP HEATER      | 13 DESCAUING      |
| 5 TEMP. L. COFFEE | 14 SIGN. DESCAL.  |
| 6 TEMP. COFFEE    | 15 TIMER          |
| 7 TEMP. S. COFFEE | 16 VENDING        |
| 8 PREBREWING      | 17 EXIT           |
| 9 PREGRINDING     |                   |

To leave the menu, move the asterisk at the end of the line to item <<Exit>> using the key v. Then, press ENT (☉ pre-ground coffee). The machine is now in the normal mode again.

**Selecting single menus**

Select the different menu items by means of the

keys ^v. The key ENT allows you to activate the selected item. It is possible to modify the selected figures in a menu item using the keys ^v. The key ENT memorizes the selected options (for instance "ON" for the cup heating plate).

Should you accidentally change some data, press ESC (\*...) to leave the menu item without saving the new options which were selected accidentally.

**Language selection**

Move the asterisk to the menu item "LANGUAGE" using the keys ^v. Press ENT to activate this item. The following message will be displayed:

"1 LANGUAGE " "  
"ENGLISH "

The keys allow you to change the set options: "ENGLISH", "ITALIANO", "FRANÇAIS", "DEUTSCH", "NEERLANDAIS", "ESPAÑOL", "PORTUGUES".

**Enabling of second heating system**

Royal Cappuccino is equipped with two boilers with independent circuits. One of these boilers can be disconnected. By pressing keys ^v move the asterisk at the end of the line to the menu item "SYSTEM 2". Press ENT to activate this item. The following message will be displayed:

"2 SYSTEM 2 " "  
"ON "

The keys ^v allow you to change the set options: ON, OFF.

If the second boiler is disconnected it is not possible to dispense steam and therefore cappuccino can't be prepared. Should the cappuccino selection button be pressed or the steam/hot water knob be opened, the display shows the following message:

"PLEASE ACTIVATE " "  
"SYSTEM 2 "

**Water hardness adjustment**

In order to adjust the water hardness, it is necessary to test the water using the strip supplied with the machine. Dip the strip into the water for a second, shake off excess water gently, wait approx. 1 minute and read the results.

Move the asterisk at the end of the line to the menu item "WATER HARDN." using the keys ^v and select it by means of the ENT button.

The following message will be displayed:

"3 WATER HARDN. / " "  
"HARDNESS 3 "

The keys ^v allow you to change the set options:

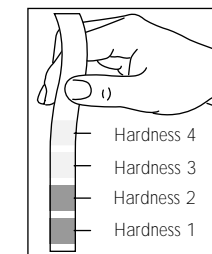

- HARDNESS 4** (hard water)
- HARDNESS 3** (medium water)
- HARDNESS 2** (soft water)
- HARDNESS 1** (very soft water)

**Cup heating plate connection**

Royal Cappuccino is equipped with a useful cup heating plate which can be disconnected, if required.

Press keys ^v to move the asterisk to item "CUP HEATER". Press ENT to activate this function.

The following message will be displayed:

"4 CUP HEATER " "  
"ON "

The keys  $\wedge \vee$  allow you to change the set options "ON" or "OFF".

### Temperature selection

With Royal Cappuccino a precise adjustment of the coffee temperature can be executed. Move the asterisk at the end of the line to the menu items "Temp. l. coffee", "Temp. coffee" or "Temp. s. coffee" and select it by means of the ENT key.

Depending on the selection, the following messages will be displayed:

```
"5 TEMP. L. COFFEE"
"MEDIUM          "

"6 TEMP. COFFEE  "
"MEDIUM          "

"7 TEMP. S. COFFEE"
```

The keys  $\wedge \vee$  allow you to change the set options "Minimum", "maximum", "high", "medium" or "low".

### Prebrewing function

As soon as the coffee has been moistened, the pump stops for a while in order to allow a better utilization of the coffee powder.

Move the asterisk at the end of the line to the menu item "PREBREWING" and select it by means of the ENT key.

The following message will be displayed:

```
"8 PREBREWING  "
"ON            "
```

The keys  $\wedge \vee$  allow you to change the set options "ON", "OFF", "LONG" (in the latter case the pump stop is longer).

### Pre-grinding function

By activating this function, grinding occurs every time the doser is empty. So a ground coffee portion is always ready in the doser, allowing a

time saving whenever the machine is often used. This function is not recommended in all other cases, because fresh ground coffee is by far better.

Press keys  $\wedge \vee$  to move the asterisk to item "PREGRINDING". Press ENT to activate this function.

The following message is displayed:

```
"9 PREGRINDING "
"ON            "
```

The keys  $\wedge \vee$  allow you to change the set options "ON", "OFF".

### Hot water programming

Whenever this function is enabled, the selected water amount is constantly dispensed. On the contrary, whenever this function is disabled hot water is dispensed until the user stops the dispensing. **Hot water amount can only be programmed with programming mode enabled.**

- "PROG. H. WATER". Press ENT to activate this function.

The following message will be displayed:

```
"10 PROG. H. WATER"
"ON                "
```

The keys  $\wedge \vee$  allow you to change the set options: "ON", "OFF".

### Cappuccino programming

Whenever this function is enabled, the same amount of cappuccino is constantly dispensed. On the contrary, whenever this function is disabled, cappuccino is brewed until the user stops the dispensing. **Cappuccino amount can only be programmed with programming mode enabled.**

Press keys  $\wedge \vee$  to move the asterisk to item "PROG.CAPUC.". Press ENT to activate this function:

The following message will be displayed:

```
"11 PROG. CAPUC. "
"ON              "
```

The keys  $\wedge \vee$  allow you to change the set options: "ON", "OFF".

Coffee counter

Press keys  $\wedge \vee$  to move the asterisk to item "TOTAL COFFEE" and select it by means of the ENT key. The following message will be displayed:

```
"12 TOTAL COFFEE "
"                XX"
```

This value cannot be modified. Quit the menu by means of the ENT or ESC keys.

### Descaling

Move the asterisk at the end of the line to menu item "Descaling" and select it by means of the ENT key.

The following message will be displayed:

```
"13 DESCALING  "
```

For descaling procedure, see page 92.

### Timer

The timer enables the automatic switching off of the machine after a preset period, which can be set from 15 minutes to 12 hours after last dispensing. If after a few seconds coffee is brewed again, the timer is reset. If the value set is 0:00, the timer function is not activated and the machine does not switch off.

Move the asterisk at the end of the line to menu item "Timer" by means of the keys  $\wedge \vee$ .

Press ENT to select this item.

The following message will be displayed:

```
"STANDBY      "
"AFTER 0:00   "
```

By means of the same keys  $\wedge \vee$ , select the suitable time and confirm the value through ENT button.

When the selected time is over the following message is displayed:

```
"ENERGY      "
"SAVING      "
```

The machine stops and can be switched on again by means of button  $\odot$  "standby".

### Vending functions

Royal Cappuccino is equipped with a counter allowing the machine statistic analysis while detecting the different dispensing operations. It is also equipped with another counter which is able to stop the dispensing operations after a certain number. These functions are protected by a special access code.

By means of keys  $\wedge \vee$  move the asterisk to item "VENDING" and select it through the ENT key. From the displayed submenu it is possible to select one of the following items by means of the same keys  $\wedge \vee$ . On the contrary, if the hot water selection key  $\downarrow$  is pressed, the submenu can be quit.

The following messages will be displayed:

```
"CODE        "
"           ****"

"1 LARGE COFFEE "
"TOTAL        "

"1 COFFEE     "
"TOTAL        "
```

```
"1 SMALL COFFEE  "
"TOTAL           "

"HOT WATER      "
"TOTAL           "

"COUNTER        "
"LOCKING        "

"COUNTER        "
"CYCLES         "
```

**Code programming**

A code protects the access to the machine counters; enter it for each programming section and before carrying out any modification. As soon as the code is entered, modifications can be carried out without entering it again as long as the programming function is enabled. The machine is not supplied with a code. Keep to the following indications for code programming:

By means of keys **^V** move the asterisk to item **"VENDING"** and select it through the **ENT** key. The following message will be displayed:

```
"CODE           "
"              *****"
```

By means of keys enter the number to be set on the first character and confirm the selection through the **ENT** key. The entered number is saved and the cursor moves automatically to the following character.

After having entered the complete new code, it is necessary to save it. The following message will be displayed:

```
"NEW CODE=XXXX  "
"SAVE NO        "
```

By means of keys **^V** the code can be saved or not saved: **YES** or **NO**.

**Code entering**

To enter the code, press keys **^V** and move the asterisk to the counter to be changed; select it through the **ENT** button. The following message will be displayed:

```
"              "CODE??  "
"              "
```

Enter the number to be set on the first character by means of keys **^V** and confirm the selection with **ENT**. The entered number is then saved and the cursor moves automatically to the following character. If a wrong code has been entered, the following message will be displayed for about two seconds:

```
"CODE FAULTY  "
```

After having entered three wrong codes, the entering procedure is not allowed any longer.

**Counter modification**

**Large coffee counter**

```
"1 LARGE COFFEE  "
"TOTAL:          XX"
```

The counter shows the large coffee amount dispensed from the last reset.

From the **VENDING** menu, move the asterisk to the **LARGE COFFEE** menu by means of keys **^V**; confirm the selection with button **ENT**.

By means of the same keys **^V** it is possible to modify the selected value (to reset the counter, for example). Use the **ENT** button to save a new value. Press the **ESC** button to stop the new value entering procedure and, as a result, the former counter setting shall be considered.

**Coffee counter**

```
"1 COFFEE       "
"TOTAL:         XX"
```

The counter shows the regular coffee amount

dispensed from the last reset.

From the **VENDING** menu, move the asterisk to the **COFFEE** menu by means of keys **^V**; confirm the selection through **ENT**.

By means of the same keys **^V**, it is possible to modify the selected value (to reset the counter, for example). Press **ENT** to save a new value. On the contrary, by pressing **ESC** the new value entering is stopped and, as a result, the former counter setting shall be considered.

**Small coffee counter**

```
"1 SMALL COFFEE  "
"TOTAL:          XX"
```

The counter shows the small coffee amount dispensed from the last reset.

From the **VENDING** menu, move the asterisk to the **SMALL COFFEE** menu by means of keys **^V**; confirm the selection through **ENT**.

By means of the same keys **^V**, it is possible to modify the selected value (to reset the counter, for example). Press **ENT** to save a new value. On the contrary, by pressing **ESC** the new value entering is stopped and, as a result, the former counter setting shall be considered.

**Hot water dispensing counter**

```
"HOT WATER      "
"TOTAL:         XX"
```

The counter shows the hot water amount (in ml) dispensed from the last reset.

From the **VENDING** menu, move the asterisk to the **HOT WATER** menu by means of keys **^V**; confirm the selection through **ENT**.

By means of the same keys **^V**, it is possible to modify the selected value (to reset the counter, for example). Press **ENT** to save a new value. On the contrary, by pressing **ESC** the new value entering is stopped and, as a result, the former counter setting shall be considered.

**Counter**

```
"COUNTER        "
"LOCKING:       XX"
```

After a certain number of cycles, this function allows to stop the coffee dispensing (excluding hot water, steam and cappuccino dispensing operations). It can also be used, for example, to program the machine servicing.

If the **0** value is set, the function is disabled.

From the **VENDING** menu, move the asterisk to the **COUNTER** menu by means of keys **^V** and confirm the selection through **ENT**.

Press the same keys to modify the selected value (for example to set a new servicing limit). Through **ENT** a new value can be saved. On the contrary, by pressing **ESC** the new value entering is stopped and, as a result, the former counter setting shall be considered.

When the set limit has been reached, the coffee dispensing stops and the following two messages are displayed:

```
"COFFEE DISPENS. "
"BLOCKED         "
```

```
"SELECT PRODUCT  "
"READY FOR USE   "
```

Reset the counters by pressing the cappuccino selection key **T**.

**Dosage of ground coffee**

**33**

The coffee dosage adjustment lever (18) allows the selection of the grinding coffee amount from 6 to 9 grams. Place lever (18) on the required position.

**RECOMMENDATIONS**

**Prolonged idleness**

If the machine hasn't been used for a prolonged

period, it is advisable for hygienic reasons to run a rinse cycle through the machine.

Place a cup under the steam/hot water spout (7) and fill it with water by operating the hot water knob.

#### Preheating cups

Cups may be preheated by placing them on the special cup heating plate.

#### Temperature led

When starting the machine, the following message is displayed:

"WARMING UP "

As soon as the operating temperature has been reached, the following message is displayed:

"SELECT PRODUCT "  
"READY FOR USE "

#### Empty coffee bean container

When coffee beans run out, the coffee grinder stops and the following message is displayed:

"COF. BEANS EMPTY "

Fill the container and restart the cycle.

#### Empty water tank

When water runs out, the program stops automatically and the following message is displayed:

"WATERTANK EMPTY "

Fill the tank and restart the cycle.

#### Grounds container warning light

As soon as there are 30 grounds in the container, the following message is displayed:

"DREGDRAWER FULL "  
"READY FOR USE "

The machine does not stop: remove the grounds container and empty it.

#### Grind adjustment

If the coffee flows too quickly (coarse grind) or too slowly (fine grind) into the cup, adjust coffee grinder. The recommended grind level is position 5.

Should grinding be too coarse, adjust it on a lower value (e.g. from 5 to 3). On the contrary, should grinding be too fine, adjust it on a higher value (e.g. from 5 to 7).



Adjust the grind level only when the coffee grinder is running. Avoid any extreme adjustment (for instance on position 1) whenever possible. It is preferable to try another coffee blend, since not all coffee blends are suitable.

#### Coffee blends

Make sure coffee is fresh. An espresso roast is preferable.

In order to obtain a strong and aromatic espresso coffee, use special blends suitable for espresso coffee machines and special cups with thick sides.

Keep coffee in a cool place, in an hermetically sealed container.

#### Operation time

The machine may be kept on all day long. However, in case of a prolonged period of idleness, it is advisable to enable the energy saving function by pressing the standby  switch. If the timer is properly programmed, this operation is automatic: for this purpose, see page 84.

In case of a prolonged period of idleness, it is advised to switch the main switch (4) off; once switched on again, the machine will be ready to be used within two minutes.

#### Switching off the machine

Switch the machine off only after the coffee cycle has been concluded.

## BREWING

Royal Cappuccino is equipped with 2 independent heating systems which may dispense at the same time coffee and hot water, coffee and steam or coffee and cappuccino.

If, during the dispensing of 2 coffees, hot water, steam or cappuccino are dispensed at the same time, it may happen that the second coffee portion is not immediately ground after the first one, but only at the end of the first coffee dispensing.

#### Cup level filling

This machine allows the precise dosage of the coffee quantity, according to the cup dimension. The desired quantity  can be selected through the selection keys. The relevant messages will be displayed.

To set the quantity of coffee to be dispensed, it is necessary to press the relevant selection key till the desired quantity of coffee is obtained (max. 250 ml approx.).

During this operation, the following message is displayed:

"1 SMALL COFFEE "  
"PROG. QUANTITY "

The machine considers automatically the necessary amounts to brew two cups of coffee.

**Attention!** If the pre-brewing function is enabled during the cups dosage adjustment, keep the selected key pressed even during the pump stop until the desired amount is reached.

#### Double quantity of coffee or 2 cups of coffee

By pressing one of the three selection keys twice, before coffee dispensing begins, the machine will brew a double portion of coffee.

#### Coffee grinding

##### 34

This machine grinds a portion of fresh coffee for

each cup; for two cups, it grinds two portions of coffee, one after the other, thus ensuring optimum coffee quality.

Adjust the grinding degree according to the instructions mentioned at page 87.



Adjust the grinding degree only when the coffee grinder is running.

#### Coffee dispensing

Place one or two preheated cups on the cupholder grill (3) under the dispenser (6). By pressing the relevant selection key, the machine will automatically dispense the selected coffee.

Dispensing may be interrupted by pressing one of the coffee selection keys, if an excessive water amount has been selected. Should you interrupt the coffee flow after the first of two coffees, the second is not dispensed.

#### Pre-ground coffee



Make sure to use pre-ground coffee only (medium ground). Never use whole beans or soluble coffee.



Right before brewing coffee, fill the container with freshly ground coffee. For best results, make sure coffee blend is fresh. Remember that ground coffee ages soon, thus losing its quality!

#### 35

Important!

Use the measuring spoon supplied to fill the container (14) with a single portion of ground coffee! Use a full measure only.

To dispense coffee, press pre-ground coffee button  and the desired selection key (large

coffee, coffee, small coffee) to obtain a cup of coffee.

**Important!** This function does not allow the double coffee cycle.

Dispensing may be interrupted by pressing one of the coffee selection keys, if an excessive water amount has been selected.

**Hot water dispensing**

Hot water dispensing is accomplished through an independent water circuit which ensures the correct temperature and supplies tasteless hot water to be used for tea, soup, etc.

By operating the hot water key, the following two messages will be displayed:

"HOT WATER	"
"READY FOR USE	"
"SELECT PRODUCT	"
"READY FOR USE	"

This happens because the machine, as mentioned before, can dispense two products at the same time.

During hot water dispensing, only the programmed amount is dispensed if the corresponding programming is enabled. On the contrary, dispensing should be stopped by pressing again the selection key when the desired amount is reached.

If hot water only is dispensed, dispensing is faster than when coffee is dispensed at the same time.

To program the hot water amount, it is necessary to keep the corresponding selection key pressed till the desired amount is reached.

**Attention: hot water can only be programmed if the corresponding programming function is enabled (see page 83).**

During the programming phase, the following message will be displayed:

"HOT WATER	"
"PROGR. QUANTITY	"

**36**

Place a glass or cup under the steam/hot water spout (7), then press the hot water selection key. Hot water will be automatically dispensed.

**Steam dispensing**

To heat milk or other drinks.



Always clean the spout with a damp cloth soon after the use; otherwise, it might be difficult to remove milk residues.



After a steam outflow, always drain the machine.

By turning steam knob (9), these two messages will be displayed:

"STEAM	"
"READY FOR USE	"
"SELECT PRODUCT	"
"READY FOR USE	"

This happens because the machine, as mentioned before, can dispense two products at the same time.

Direct steam/hot water spout (7) on cup holder grill (3) and slightly open knob (9), turning it counterclockwise.

Wait until the remaining water has flown out of the spout. Then, move the spout outwards and plunge it deeply into the fluid to be heated.

**37**

Slowly open the steam/hot water knob and heat the fluid, with a circular movement from the bottom to the top.

When the fluid has reached the desired tempe-

ature, close the knob and immediately clean the spout with a damp cloth.

**Attention:** the spout is hot, it may cause burns!

**Cappuccino**

Through the special Cappuccinatore, this machine can brew a real cappuccino without any problem. By pressing the cappuccino button, these two messages will be alternately displayed:

"CAPPUCCINO	"
"READY FOR USE	"
"SELECT FOR USE	"
"READY FOR USE	"

That is because the machine, as mentioned before, can dispense two products at the same time.

**USER MAINTENANCE INSTRUCTIONS**

**INCORPORATED SAFETY DEVICES**

During the cappuccino dispensing, only the programmed amount is dispensed if the corresponding programming is enabled. On the contrary, dispensing should be stopped by pressing again the selection key when the desired cappuccino amount has been reached.

To program the cappuccino amount, it is necessary to keep the corresponding selection key pressed till the desired amount is reached.

**Attention: cappuccino amount can only be programmed if the corresponding programming function is enabled (see page 83).**

**38**

For cappuccino dispensing, fit suction pipe (26) of the Cappuccinatore (25) in a milk container or in another container. To prevent milk container deformation, pierce it on the top to allow air entry. Place the cup under dispenser (27) and press the

cappuccino selection key.

Cappuccino dispensing can be adjusted by turning the special Cappuccinatore adjustment valve (28).

**Note:** it is suggested to use milk with low fat amounts (1.5%).

**Cappuccinatore cleaning**

Let the Cappuccinatore drain a full water container after each cappuccino dispensing: in this way, the device will be perfectly cleaned.

**Incorporated safety devices Automatic off**

Should the service door be open, the machine automatically switches off. If the central unit is not mounted, only water and steam can be dispensed.

**Electronic grinding time control**

As soon as the coffee bean container is empty, grinding automatically stops after 20 seconds approx. Fill the container with coffee beans, as shown at page 80.

**Electronic pump control**

The machine switches off automatically as soon as the water in the tank is under the minimum level checked by a special water level indicator (73). Fill the tank according to the procedure shown at page 80.

**Electronic temperature adjustment**

Said adjustment controls the correct temperature to brew coffee and to dispense hot water and steam. Coffee brewing is automatically interrupted should the water temperature be excessive (safety thermostat and overheating safety device activated).

**Antigravel device**

Even selected coffees may contain impurities. To avoid damages, the coffee grinder is fitted with an antigravel device against impurities. Should gravel end up into the coffee grinder, you will hear a strong and characteristic noise. Stop the machine immediately otherwise the machine will automatically stop within 20 seconds thanks

to the special electronic protection system.

**Important:** Do not start the machine before the foreign body has been removed, otherwise the motor may be damaged. Procedures: see page 92, points 45-49.

### Cleaning and maintenance operations

#### General cleaning

To ensure a good coffee quality and a longer working life, always keep the machine clean.



Before cleaning the machine, turn off the main switch, unplug the machine and wait until it cools down.



Do not immerse the machine into water or other fluids: it may be irreparably damaged!



Do not wash parts of the machine in the dishwasher!



Always handdry all parts of the machine, do not dry them in the oven or microwave oven!

#### Water tank, drip tray, coffee grounds container and coffee dispenser 39

In order to keep the service area and the central unit (22) clean, daily empty the coffee grounds container (1), after machine use.

The water tank (11), drip tray (2), cup holder grill (3) and coffee grounds container (1) should be washed periodically, using a non-abrasive solvent and drying them carefully.

#### 40

Coffee dispenser (4) may be removed for cleaning

operations. Unloose the screws and rinse the dispensing tube thoroughly with hot water.

From time to time, clean the machine casing with a damp cloth and dry it.

Clean pre-ground coffee container (14) with the aid of the brush supplied, whenever necessary.

#### Central unit

Clean central unit (22) whenever the coffee bean container is filled, or at least once a week.

Switch off the machine and open service door (19). Remove grounds coffee container (1).

#### 41

Remove central unit (22), by holding the handle and shortly pressing the PRESS key.

Wash the central unit with hot water; **do not use any solvent.**

#### 42

Make sure there are no coffee residues on the two steel filters: the upper filter can be removed by unloosening and turning the plastic pin anticlockwise using the tool supplied.

Dry thoroughly each central unit component, fit the filter again and tighten it properly with the screw.

#### 43

Remove coffee rest drawer (23) and clean it, using a non-abrasive solvent.

Clean the service area thoroughly and fit the coffee rest drawer again.

#### 44

By holding the central unit by its handle, slide it back into its original position, making sure it is correctly engaged. Then close the door. Fit the coffee grounds container again.



**When fitting the central unit, do not press "PRESS" button: it may cause**

### irreparable damages to the machine!

**Warning:** if the central unit is not correctly fitted, the following message will be displayed:

"BREW UNIT MISS "

The machine cannot dispense coffee.

#### Coffee grinder



Never fill the coffee grinder with water: it may irreparably damage the machine!

#### 45

Clean the coffee beans container periodically; **this operation should be accomplished by a qualified technician!** Unplug the machine.

Empty the coffee container and unloose the two fastening screws. Now, the container can be removed and cleaned.

#### 46

Carefully pull the adjustment lever upwards, previously writing the set grinding degree.

#### 47

Turn the adjustment ring counterclockwise, until the blue marks coincide.

#### 48

Now, it is possible to remove the grinding ring from the machine, slightly pulling it upwards.

#### 49

With the aid of a brush or a narrow vacuum hose, clean both the gear box and the grind ring support.

Make sure the position of the grind ring does not shift.

To reassemble the coffee grinder, carry out the reverse sequence, making sure the adjustment ring has not been shifted during cleaning. If that is the case, turn it until the blue mark coincide with one of the three notches.

Assemble the grind ring support and make sure the blue marks coincide.

#### 50

Turn the adjustment ring clockwise, to make the red marks coincide.

#### 51

Fit the adjustment lever on the ring, until it coincides with the previously set grinding degree.

#### Cappuccinatore

#### 52

To quickly clean the cappuccinatore, immerse the suction pipe into warm water and let water flow through it.

For a more accurate cleaning, remove the cappuccinatore and open cover (29). Clean the outside part with warm water and rinse it with cleaned water.

#### Descaling

**Attention: The descaling operations must be carried out when the machine components are cold.**

Descaling removes limescale from all surfaces and holes, thus ensuring a perfect operation of valves, heating controls and other important parts.

**Note:** due to the complexity of the coffee machine hydraulic circuit, the following descaling cycles (automatic and standard) do not allow the descaling of all tubes.

**In fact, easily accessible components such as the central unit (22) and its plastic connection are excluded.**

The machine must be descaled every 3-4 months, depending on the water hardness degree.

A more frequent descaling is recommended wherever the water hardness degree is very high. To avoid dangerous delays to users, this machine is supplied with a special control counter, reminding the user to perform this operation, according to the water hardness degree.

In this case, the following message will be displayed:

"DESCALING "

When this message is displayed, the machine does not stop; however, it is suggested to descale quickly the machine.

To cancel the message, see programming menu indications, point 14.

The machine has been adjusted on a 25°dH value, which causes the warning light to switch on after 150 l approx.

Should it be necessary, the water hardness value may be exactly programmed, following the instructions shown at page 82.

The following adjustments are possible:

**Hardness 4:** high water hardness, over 29°dH (14°dH), i.e. 80 l water approx.

**Hardness 3:** medium water hardness, approx. 20-29°dH (7-14°dH), approx. 150 l water passage.

**Hardness 2:** soft water, approx. 12-20°dH (4-7°dH) approx. 300 l water passage

**Hardness 1:** very soft water, less than 10°dH (3°dH), approx. 500 l water passage

In hard water regions, a filter should be used both to improve the coffee quality or to protect the machine, thus reducing the descaling frequency.

**Note:** for this purpose, use a descaling product suitable for coffee machines.

#### Never use vinegar!

Descaling can be performed in two ways:

#### Automatic descaling

Select this mode in the programming menu (see page 84).

By means of keys  $\wedge \vee$ , move the asterisk at the end of the line on the menu item **Descaling** and confirm the selection with the **ENT** key.

The following message will be displayed:

"13 DESCALING "

Pour a descaling solution into the water tank (according to the instructions on the product package). Switch the machine on the programming mode. Place a large container under the steam/hot water spout and open slowly the steam knob. The automatic descaling starts: Small amounts of descaling solution are pumped into the circuit. Then the pump stops to let the solution take effect. During this phase, the following message is displayed:

"MACHINE IS  
"DESCALING "

After approx. 45 minutes, when the procedure is accomplished, the following message will be displayed:

"DESCALING "  
"FINISHED "

Close the steam knob. The pump stops. Press **ENT** button. A display message reminds you to rinse away any possible descaling residues from the machine.

"RINSE MACHINE "

Remove water tank, rinse it accurately and fill it with fresh water. Clean the machine using the hot water knob and let the whole tank content flow out. The following message will be displayed:

"RINSING "  
"FINISHED "

Press the hot water key again. Go back to programming function by pressing the **ENT** key.

**Note:** By pressing the **ESC** key, it is possible to quit descaling procedure.

#### Reset descaling message

In programming function, by pressing keys  $\wedge \vee$ , move the asterisk till the end of the line on the menu **Sign. Descal** and confirm the selection with **ENT** button.

The following message will be displayed:

"RESET DESCALING "  
"NO "

By means of the same keys  $\wedge \vee$ , it is possible to modify the value; **Yes** or **no**.

Through this reset operation, the internal counters of the two water systems are reset and the message **DESCALE** is erased.

If the function

"SIGN. DESCAL. "

is selected without the displayed message **Descale**, the following message will be displayed:

"QUANTITY WATER "  
"NOT REACHED "

#### Standard descaling

Switch off the machine. Pour a descaling solution into the water tank (according to the instructions on the product package). Place a large container under the steam/hot water spout (7). Switch the machine on by pressing the main switch, press the hot water key and let the descaling solution in the water tank pour out of the spout for 1 minute approx.

Press hot water key to complete the operation. Switch the machine off and let the solution taking effect for 5 minutes approx. Repeat this procedure two or three times, to empty the water tank.

As soon as descaling has been performed, rinse the water tank (11) thoroughly and fill it with fresh water.

Switch on the machine again and let water (2 l approx.) flow out of the steam/hot water dispensing tube in order to rinse away residues.

#### Important:

A periodic descaling ensures a correct machine functioning and avoids expensive repairs. The machine warranty does not cover damages

occurring as a result of the non-observance of descaling procedures, improper use and non-observance of any other instruction contained herein. Maintain the manufacturer's adjustment if the water hardness degree is not known.

#### Disposal

Machines which are no longer operational should immediately be made non serviceable, by cutting the power cord. Machines should be delivered to a public disposal centre.

Switch off and unplug the machine if it will not be used for long periods.

Cut the supply power cord and deliver the machine to a public collecting point.



Should the machine not be used anymore, switch it off and unplug it.



Keep the machine in a dry place, far from the reach of children.

Should the machine not be used for a long period, keep it from dust and dirt

#### Maintenance

Periodically check the machine working and clean it in accordance to the instructions.

#### Troubleshooting



In case of failure, fault or suspected damage following a fall, unplug the machine immediately.

To fix problems, follow the instructions in the table. Otherwise contact authorised personnel. Only skilled personnel are authorised to repair the machine. The user might incur serious injuries should repairs not be properly carried out.

The manufacturer declines any liability whatsoever, should repairs fail to be carried out according to the instructions contained in this manual. Furthermore in these cases warranty rights cannot be honored.

## IMPORTANT SAFEGUARDS

When using your coffee maker, basic safety precautions should always be followed, including the followed to reduce the risk of fire, electric shock, and/or injury to persons including the following:

- 1 ● Read all instructions.
- 2 ● Do not touch hot surfaces. Use handles or knobs.
- 3 ● To protect against electric shock, do not place cord, plug or appliance in water or other liquid.
- 4 ● Close supervision is necessary when any appliance is used by or near children.
- 5 ● Unplug from the outlet when not in use and before cleaning. Allow to cool before putting on or taking off parts, and before cleaning the appliance.
- 6 ● Do not operate any appliance with a damaged cord or plug or after the appliance malfunctions, or has been

damaged in any manner. Return appliance to an authorised service facility for examination, repair or adjustment.

- 7 ● The use of an accessory not evaluated for use with this appliance may cause injuries.
- 8 ● Do not use outdoors.
- 9 ● Do not let cord hang over edge or table or counter, or touch hot surfaces.
- 10 ● Do not place on or near a hot gas or electric burner, or in a heated oven.
- 11 ● Always attach plug to appliance first, then plug cord into the wall outlet. To disconnect, turn any control to the off position, then remove plug from wall outlet.
- 12 ● Use this appliance only for its intended use as described in this manual.
- 13 ● Keep the cord away from heated surfaces.

## SAVE THESE INSTRUCTIONS

### WARNING

**RISK OF FIRE OR ELECTRIC SHOCK  
DO NOT OPEN**

**WARNING: TO REDUCE THE RISK OF FIRE OR ELECTRIC SHOCK.  
DO NOT REMOVE COVER (OR BACK)  
NO USER-SERVICEABLE PARTS INSIDE  
REPAIR SHOULD BE DONE BY AUTHORIZED SERVICE PERSONNEL ONLY**

Trouble	Possible causes	Solution
No message is displayed	The machine is not getting power	Turn the main switch on, check plug and fuse
	The service door is open	Close the service door is
The automatic coffee brewing does not start	<b>BREW UNIT MISS.</b>	Properly fit and lock the central unit
	<b>BREW UNIT BLOCK.</b>	Clean the central unit (see page 91)
	<b>WATERTANK EMPTY</b> <b>COF. BEANS EMPTY</b>	Fill with water or coffee beans and restart the cycle
The automatic coffee brewing does not start	<b>DREGDRAWER MISS.</b>	Fit the coffee grounds container properly
	<b>GRINDER BLOCKED</b>	Service the coffee grinder (see page 92)
Steam and hot water are not dispensed	The steam/hot water spout hole is clogged	Clear the hole with the aid of a thin needle
Coffee is dispensed too quickly	Grinding too coarse	Adjust the grinder on a finer grinding, e.g. from 5 to 3
Coffee is dispensed too slowly	Grinding too fine	Adjust the grinder on a coarser grinding, e.g. from 5 to 7
Coffee is not hot enough	The central unit filter is clogged	Clean the filter
	The cup has not been preheated	Heat the cup on the heating plate
Coffee is not creamy enough	The coffee blend is not suitable or is not fresh. Grinding is not correct (too fine or too coarse)	Try another coffee blend
The machine coffee brewing is reduced, it takes longer to heat and the dispensing is not sufficient	Descaling the machine	Descalate the machine, as described at page 92
The central unit cannot be removed	The central unit has not been correctly positioned	Switch the machine on, close the service door, fit the coffee grounds container and wait until the machine resets.